

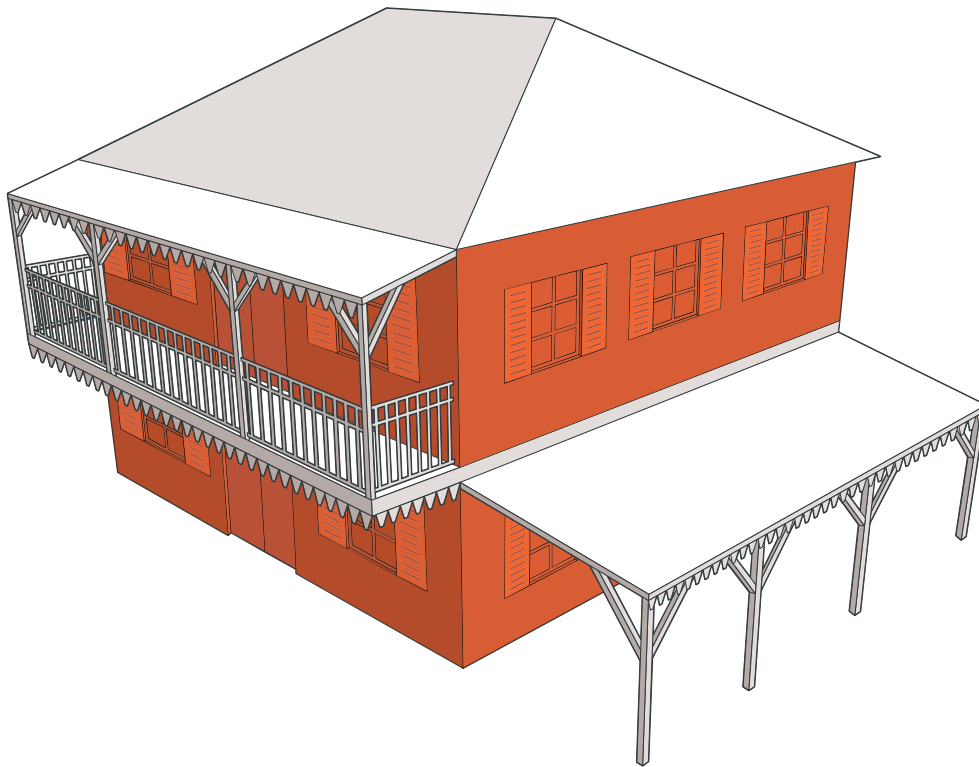

MASONRY



Practical Information Sheet

Professionals



N°4



Contents

Foreword.....	4
Failure modes under the effects of wind.....	5
Repairing the confining elements beneath the frame.....	7
Choice of materials	12
Masonry units.....	15
Repairing an entire wall	17
Chasing	20
Tools and storage.....	21
Maintenance.....	22
Glossary.....	23
References.....	23

FOREWORD

This practical information sheet provides indications on installing masonry walls. It presents individual points that have a direct influence on how well the walls will stand up to the effects of wind and seismic activity.

Details on how to implement these features in relation to other requirements are not covered here.



Figure 1: Exposed structures that survived

The figures given concern simple structures with the following characteristics:

- A maximum of 2 levels;
- A surface area per level $\leq 100 \text{ m}^2$;
- A maximum height per level of 3 m;
- A square ($10 \times 10 \text{ m}^2$) or rectangular shape with a ratio between the two sides of less than 2 (e.g. $7 \times 14 \text{ m}^2$);

Other constructions can follow the same indications with the proviso that a design office with expertise in structural design is consulted.

This information sheet is intended to cover repairs. Its objective therefore involves the rebuilding of damaged walls. A design office should also be consulted when complete rebuilding is necessary.

FAILURE MODES UNDER THE EFFECTS OF WIND

Masonry structures were not impacted to any great extent by Hurricane Irma, even when most exposed (Figure 1). Several types of damage were observed:

- Indirect damage, e.g. frames ripped out causing localised masonry breakages.
- Confining elements missing.
- Foundations missing in the most serious cases.

Please note that masonry structures are more vulnerable to seismic activity than they are to wind damage. The structures left with damage in the wake of Hurricane Irma would most probably not have survived a medium amplitude earthquake.

Figure 2 shows one of the rare examples of damage to masonry structures. It is highly likely that the structure had existing defects that may or may not have been visible prior to the hurricane. Please note that there are no immediate safety implications with this type of damage.



Figure 2: Damaged structure at the confining elements

The cracks that are visible follow the exact path of the confining elements. This could be due to the voids between the posts and beams being filled with masonry and the cross-sections of the beams not being substantial enough. The structure must be repaired so that an appropriate level of earthquake-proofing is restored.

Figure 3 shows a break in the structural wall due to the frame timber being ripped out. This is probably due to the frame not being correctly tied into the rest of the construction. Installing rafters by “wedging them” into the masonry is very popular in Saint Martin, but it should be strictly avoided.



Figure 3: Breaks due to the frame being ripped out

REPAIRING THE CONFINING ELEMENTS BENEATH THE FRAME

■ Old “wedged-in” connection

This configuration is to be avoided as it has been at the root of numerous frame breakages (see Figure 4 below). The link between the masonry and the frame must be able to resist roof uplift caused by hurricane-force winds. The repair principle set out here is to reconstitute a mechanical link that is resistant to tensile forces.

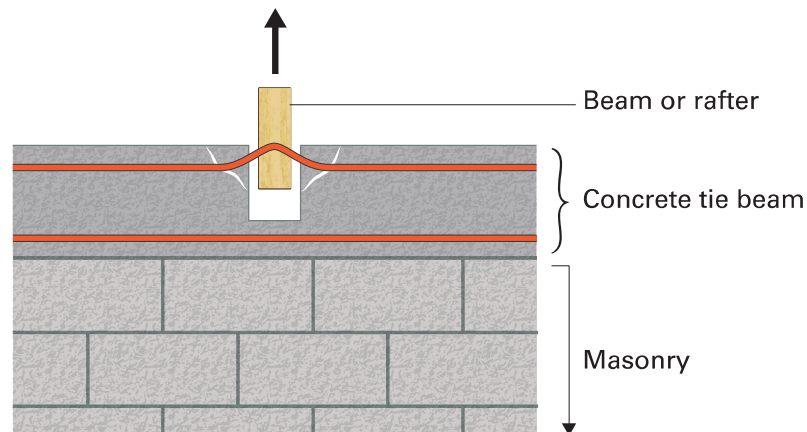

Figure 4: Principle involved in the observed failures: the rafter has been pulled out of its housing.

Once the rafter has been removed, the first thing to do is to check for a tie beam to which timbers can be fixed. The only way to do this effectively is by using a steel detector. There are two possible outcomes:

- Figure 5: the reinforcing steel is not all continuous around the rafter position.
- Figure 6: the tie beam is situated underneath the rafter and is fully continuous.

In the first case, the tie beam is not up to performing its function of withstanding seismic and wind loads. The tie beam, if not the whole wall, must therefore be rebuilt in accordance with the indications given in the remainder of this information sheet.

In the second case, the damage can be repaired.

✓ *Note: using an electronic steel detector should be left to professionals with the necessary skills to interpret the results correctly.*

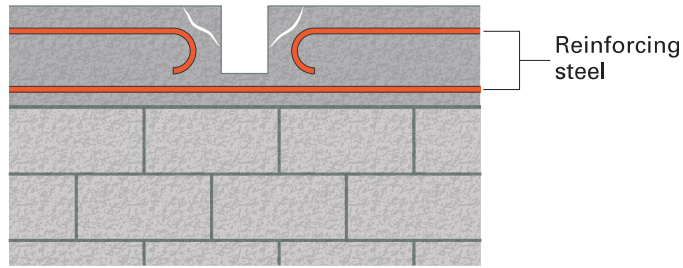

Figure 5: Discontinuous tie beam

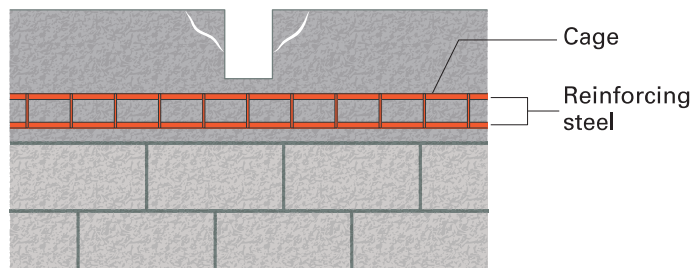

Figure 6: Continuous tie beam

The repair involves:

- Removing the damaged concrete;
- Making enough room to install the new frame and its fixings (allow for the width of the timber + 40 cm). Wherever possible, use a diamond blade to do the cutting;
- Apply a layer of repair mortar approximately 5 cm deep to obtain a flat, horizontal surface;
- Wait at least 7 days before installing the fixings for the new frame. Important note: The anchor bolts must be long enough to engage with the tie beam, which in most cases means at least 12 cm.

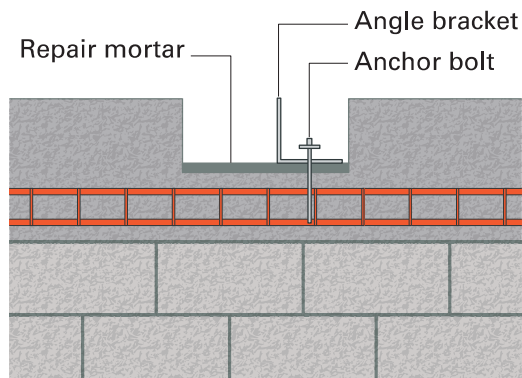

Figure 7: New fixing

✓ *Note: for details on the new fixings, see the information sheet on timber frames.*

■ Angle bracket fixing

Frame fixing angle bracket and plate failures have been observed. These failures are generally due to the brackets being too thin or the anchor bolts being too short. The principal failure mode is breakage of the concrete in the top part of the tie beam (Figure 8).

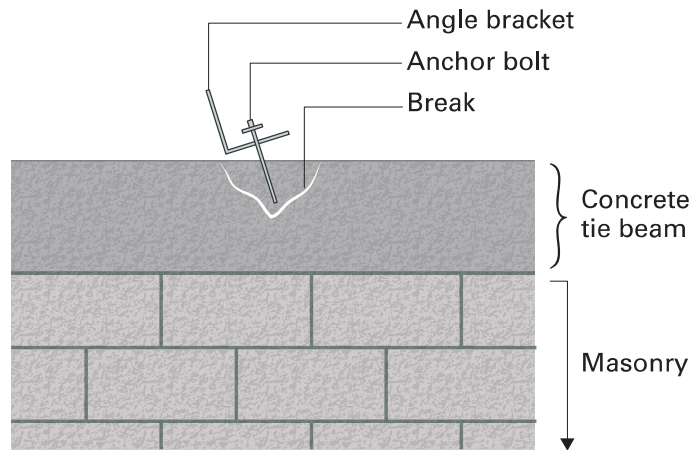

Figure 8: Broken angle bracket fixing

The first job to do is check that the tie beam reinforcing bars have not been affected. To do this, any concrete still remaining in the area that failed must be removed. If a reinforcing bar appears and is broken (Figure 9), the whole tie beam will have to be redone in accordance with the indications given in the remainder of this information sheet.

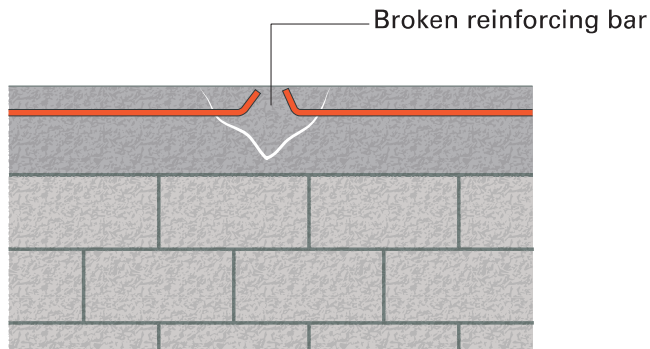

Figure 9: Broken reinforcing bar requiring the whole tie beam to be redone

If the reinforcing bars have not been affected, the repair will consist of:

- Removing the damaged concrete;
- Removing the concrete around the reinforcing bars in the area to repair;
- Applying an anti-corrosion coating to the reinforcing steel;
- Filling the hole back in with repair mortar.

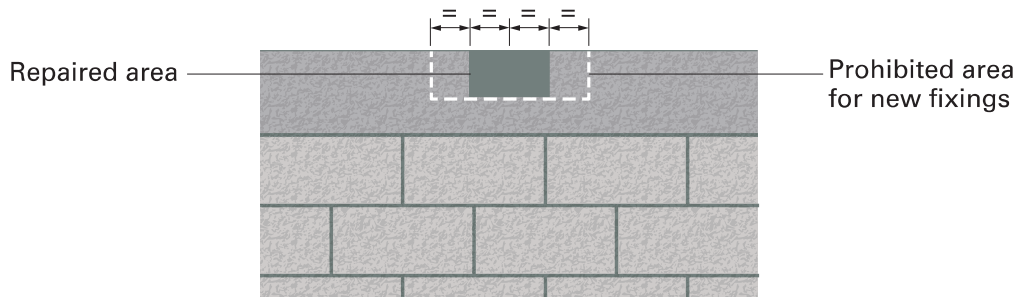

Figure 10: Filling the damaged area back in

✓ *Important note: No fixings are allowed in the area around the repair after its completion. New fixings are prohibited in an area equal to half the repaired area either side of it (Figure 10)..*

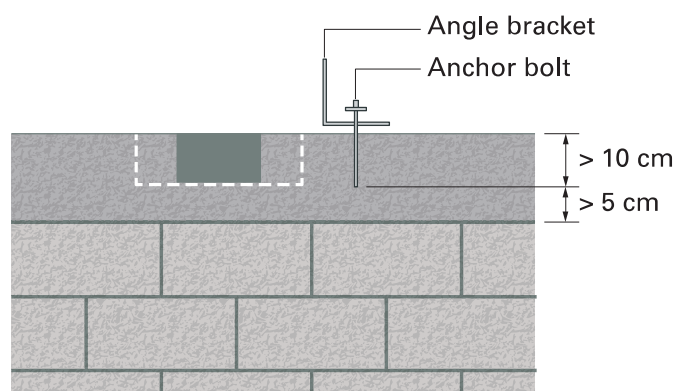

Figure 11: New fixing

New angle brackets can be fixed outside the prohibited area. Make sure that the anchor bolts used are long enough to reach the reinforcing steel. By default, a length equal to the height of the tie beam less 5 cm is required.

Figure 12 shows a common method of building frames in Saint-Martin. When structures are being repaired, it can be used subject to the following precautions a plastic film must be placed between the wood and the concrete before pouring;

- the reinforcing steel mesh must be galvanized there are 3 frames for the steel mesh there are 3 frames for the steel mesh on each side of the rafter, spaced 10 cm apart.

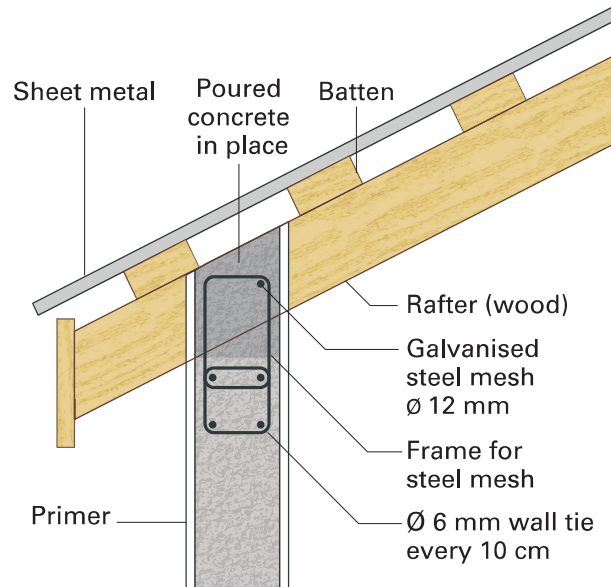

Figure 12: Common method of building frames in Saint Martin

✓ *Note: this configuration, although common in Saint-Martin, does not offer the same safety levels as new constructions. It is reserved for repairs to existing structures.*

CHOICE OF MATERIALS

Choosing the right building materials and products is of prime importance to the safety and durability of the buildings. This information sheet provides selection criteria for choosing these products. The performance levels meeting the criteria must be specified by the manufacturer and marked directly on the product or the accompanying label. For this information to be usable, it must be specified in a precise format, namely the format associated with the CE mark.



Figure 13: Logo that must be displayed on products bearing the CE mark

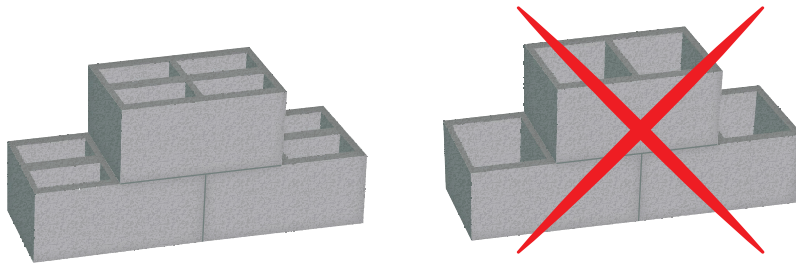

Figure 14: Choosing the components

■ Masonry units

The masonry units used in building structures must have the following characteristics:

- An intermediate longitudinal partition;
- The hollow parts should be at least 20 cm thick (thickness of the wall);
- A vertical compression strength of at least 4 MPa; The manufacturer's reference should be B40 or Rc40;
- A horizontal compression strength of at least 1.5 MPa. The manufacturer must indicate that the block is suitable for use in earthquake zones; this may be in the form of a simple statement.

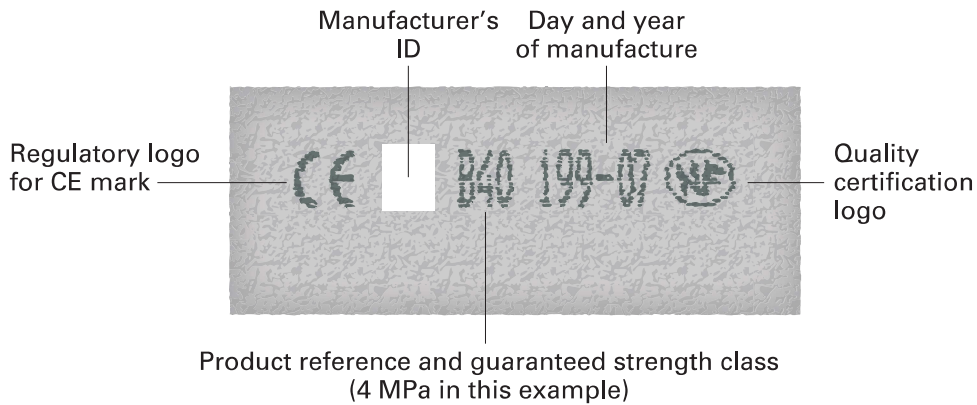

Figure 15: Example of the markings on a concrete block

■ Mortar

The mortar must have a minimum strength of 10 MPa, i.e. class M10. The best solution is to buy bags of dry, ready-mixed mortar to mix with water. Failing that, use the following mixture:

Class M10 mortar	Cement (kg) CEM I CEM II	Masonry cement (kg)	Sand
Pure mortar binder	300 to 400	350 to 450	0/2 or 0/4 ≤ 5% of fine grains

■ Quick Reference

Cement mortar mixtures:

1 x 25 kg bag of cement
6 x 10 litre buckets of sand
1 x 10 litre bucket of water
Overall volume of mortar 90 litres

1 x 35 kg bag of cement
9 x 10 litre buckets of sand
1.5 x 10 litre buckets of water
Overall volume of mortar 130 litres

- ✓ *Important note: The moisture content of the sand varies enormously with the seasons and storage conditions => start by adding 8 litres of water and progressively add more until you get the right consistency: a uniform, supple paste that makes your gloves wet but does not run.*

■ Concrete

Tie beam concrete must be fluid enough to fill in the tie beam reinforcing bars properly and the grains should not be too large.

You can use:

- ready-to-use concrete, class C25/30 or better;
- cement concrete mixed on site, with a plastic (class S3) consistency and a minimum cement content of 400 kg/m³ mixed with aggregate with a maximum grain size of 10 mm for the vertical confining elements (ideally 3/8) and 14 mm maximum for the horizontal confining elements.

	Cement	Aggregate	Sand	Water
Tie beam concrete	400 kg	980 kg	720 kg	195 l

✓ *Note: beach sand must never be used for making either mortar or concrete.*

■ Reinforcing bars

The reinforcing bars used in confining elements and complementary reinforced concrete structures must have the following properties:

- HA, High Adhesion (ribbed) reinforcing bars (not smooth reinforcing bars).
- Ductility class B or C: indicated by the manufacturer.
- 500 MPa elastic limit.
- Current reference: B500 B.

In the case of confining elements, the recommendation is to buy prefabricated reinforcements with 4 x 10 or 12 mm longitudinal bars and 6 mm cages (depending on availability).

✓ *Note: the NF reinforcement certification (NF logo on the labels) makes it easier to spot reinforcements that are suitable for use in projects covered by this information sheet.*

MASONRY STRUCTURE DESIGN

When repairing masonry walls, the initial design of the structure must be checked to make sure it has not been modified. The main points are listed below.

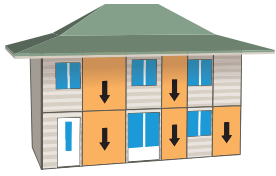

Bracing panel continuity

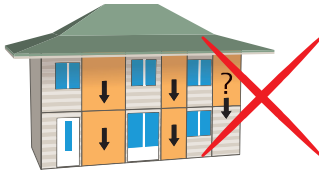

Hanging upper floor bracing wall: not permitted

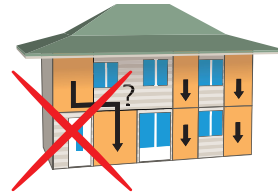

No direct force transmission: not permitted on masonry or reinforced concrete, conditional for timber and metal structures

Figure 16: Bracing continuity

As shown in Figure 16, wind-resistant masonry walls must always be fully supported by other wind-resistant walls. The confining elements must also be in alignment so that they can take up the tensile forces (Figure 17).

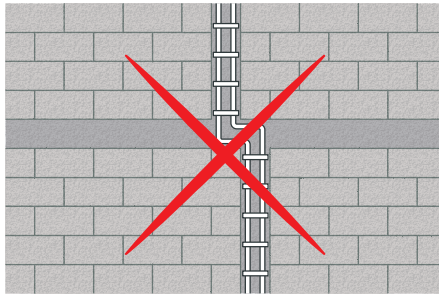

Figure 17: The confining elements must be in alignment

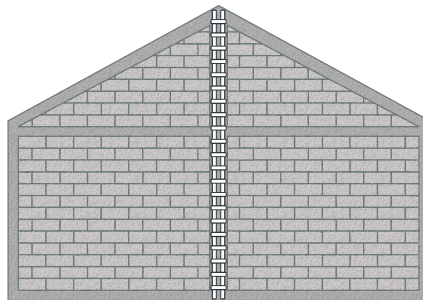

Figure 18: Tie beam over the entire elevation

Confining elements must run from the foundations to the top of the house. This is particularly important in the case of gable walls (Figure 18).

Above ground, horizontal confining elements are situated at each floor level. These are comprised of a minimum of 4 x HA12 reinforcing bars with HA6 cages every 150 mm. The vertical confining elements can be arranged as shown in Figure 18. They must be installed:

- At both ends of wind/earthquake-resistant walls;
- On the exposed edge of protruding walls;
- Either side of openings;
- At wall intersections;
- Every 5 m maximum on solid walls.



Figure 19: Example of vertical tie beam arrangement

REPAIRING AN ENTIRE WALL

This paragraph presents the building provisions that must be incorporated into walls designed to stand up to wind and earthquakes. These types of repair involve heavy construction and should be left to professionals working to designs produced by a design office.

■ Masonry

The masonry units are built up by stacking them on top of mortar beds. The units must overlap to give the wall its strength (also known as staggering or bonding).

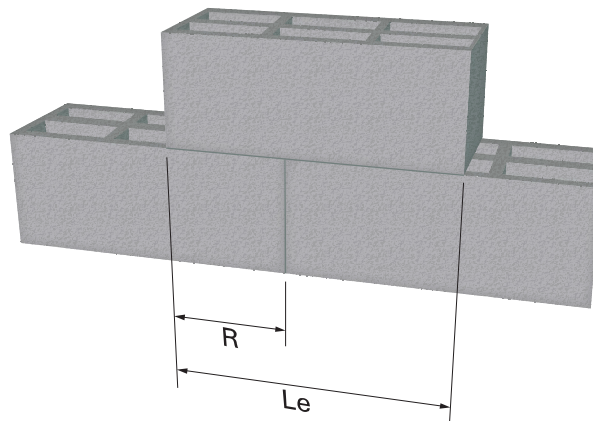

Figure 20: Overlapping masonry units

The recommended overlap, R , between two adjacent rows is between 0.4 and 0.5 times the length of the masonry unit (Le). See Figure 20.

The mortar is applied to all the solid surfaces of the masonry unit. When the top masonry unit is laid, the final thickness of the mortar joint should be between 6 and 15 mm.

Mortar should also be applied to the vertical sides of the masonry units before they are laid, so as to make a mortar joint approximately 1 cm thick between the masonry units, spanning the width of the wall.

■ Confining elements

The reinforced concrete confining elements are the second most important element in ensuring wall strength after the masonry. To ensure these beams fulfil their role properly, the following rules must be adhered to:

- The cross section of the tie beam must be large enough to house a 15 x 15 cm square.
- The tie beam must be poured after the masonry has been laid.
- The tie beam reinforcing bars must be filled in properly. Particular attention should be paid to the vertical confining elements (making sure that the indications concerning the concrete mix above are adhered to). The best way to achieve this is to vibrate the concrete whenever possible.
- The confining elements must contain at least 4 longitudinal HA10 or HA12 reinforcing bars.
- Make sure the reinforcing bars overlap at the connection points by at least 60 times their diameter ($\varnothing 60$). This amounts to 60 cm for HA10 reinforcing bars and 72 cm for HA12 reinforcing bars.

Figure 21 and Figure 22 show the two possible corner arrangements. Two important points:

- 1) The connection reinforcing bars must have the same cross-section as the tie beam reinforcing bars (HA10 or HA12).
- 2) The overlaps (shown as $\text{Ø } 60$ on the diagrams) apply to each of the 4 tie beam reinforcing bars.

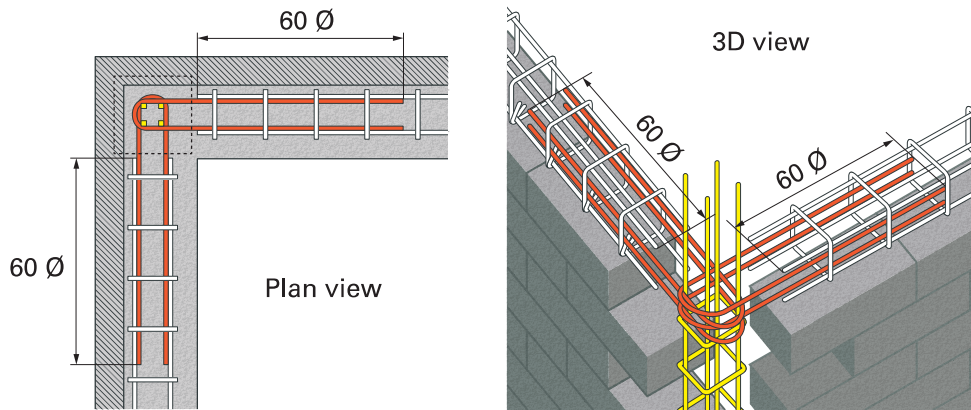

Figure 21: Looped corner connection

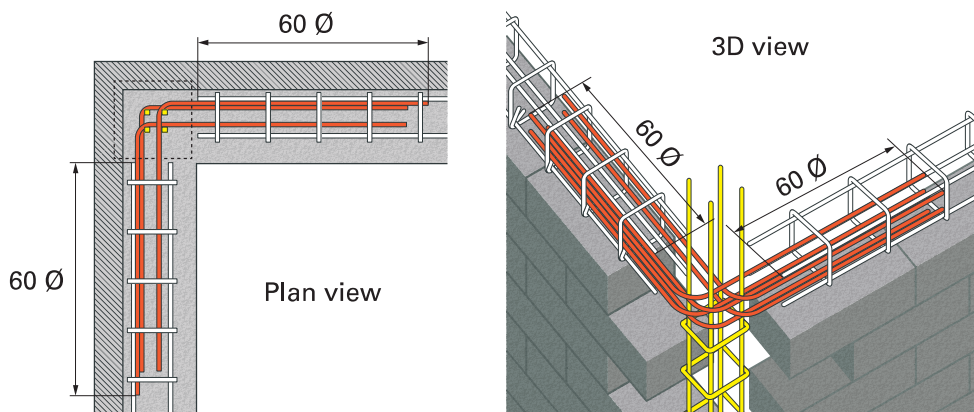

Figure 22: Right-angled corner connection

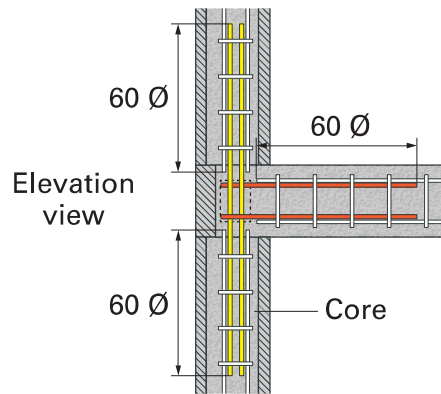

Figure 23: Connection with a reinforced concrete floor.

Figure 23 details the connection between a vertical tie beam and a floor in the main span of a wall. The same two important points as those applying to the corner connections apply.

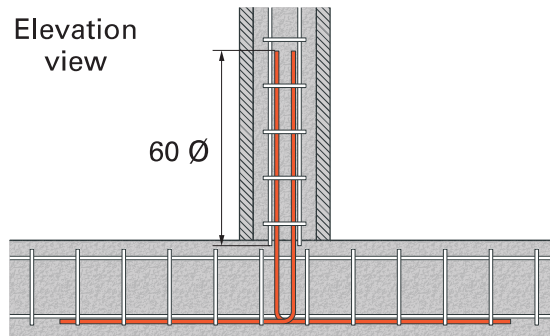

Figure 24: Connection with a dividing wall

Figure 24 shows the connection between an interior masonry wall and a continuous concrete façade wall. The arrangement would be the same with a masonry façade.

CHASING

Chasing into masonry walls designed to stand up to earthquakes and high winds so that networks can be installed should be avoided as much as possible. If chasing is unavoidable, the chases must be refilled to restore the integrity of the wall. This involves using cement mortar with a 350 kg/m³ cement content and a resin-based additive or using a structural repair mortar.

In any event, the widest permissible chase is 60 mm. Successive parallel vertical chases must be separated by at least 1.20 m. If a primary wall has more than two vertical chases, it must not have any horizontal chases.

✓ *Note: Chasing into lintels and confining elements is prohibited.*

TOOLS AND STORAGE

The tools needed are conventional bricklayers' tools. It is recommended that you use a cement mixer on site so that you can make mortar and concrete that is consistent and uniform.

A mallet will be needed to level the masonry units without running the risk of damaging their edges. A hammer can be used as long as a piece of wood is placed between it and the masonry unit.

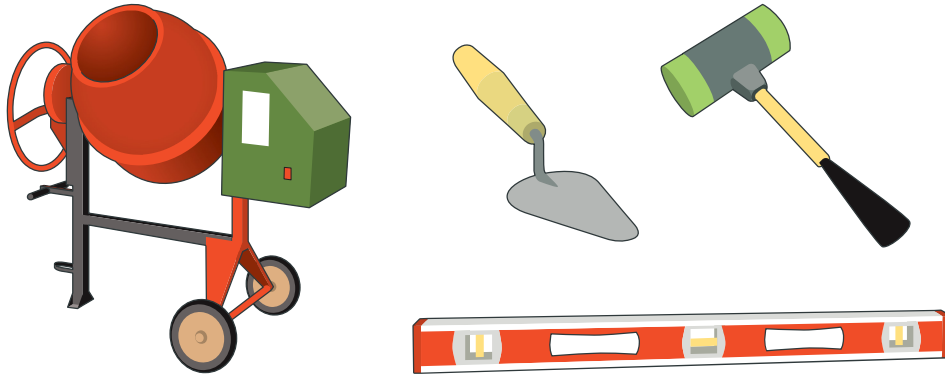

Figure 25: Tools

The materials should be protected from bad weather as much as possible. The cement and mortar should be kept in sealed bags on pallets covered with a tarpaulin (outside).

If they are to be stored for more than a few days, the reinforcing bars for the reinforced concrete should be stored on a flat surface, away from moisture. They should not be left in direct contact with the ground. If the reinforcing bars are spattered with earth, they must be cleaned off prior to use.

Aggregate should ideally be delivered in Big Bags which should remain closed and covered with a tarpaulin.

MAINTENANCE

Maintenance of masonry structures must be carried out once per year, when the hurricane season is approaching. At that time, an inspection should be performed to ensure that there has been no premature degradation.

Please note that maintenance will be a great deal easier to carry out if the façade is covered with a light-coloured coating. This will protect the masonry from water ingress, which could damage the reinforcing bars over time.

With this coating, maintenance only involves:

- Façade coating: checking for cracks. If there is any significant cracking, the coating will have to be removed and reapplied.
- Masonry: checking for localised cracks with running rust stains. In such cases, the reinforcement must be exposed and treated and the hole refilled with repair mortar.

If there are large cracks in the masonry, you must consult a design office to analyse the causes and find solutions to the problem.

Glossary

Aggregate: sand and gravel for mixing into concrete.

Masonry unit: concrete block or fired clay brick meeting the requirements mentioned in this information sheet.

Masonry unit overlap: also known as bonding or staggering; this refers to the offsetting of masonry units from one row to the next.

Reinforcing bar overlap: the superimposition distance of two reinforcing bars to ensure the load is transferred properly from one bar to the other.

Reinforcing bars (rebars) or steel: factory ribbed steel bars intended for incorporation into concrete.

Repair mortar: ready-to-use mortar or dry mortar to mix with water with a specific formula for replacing damaged concrete.

Tie beam: reinforced concrete elements poured around masonry units and intended to strengthen the wall.

References

NF DTU 20.1 (P10-202) : Ouvrages en maçonnerie de petits éléments - Parois et murs (Small masonry unit walls – Partitions and walls)

Construction parasismique des maisons individuelles aux Antilles « Guide CP-MI Antilles » – Recommandation AFPS tome IV

Règles Antilles – révision 1992

Eurocode 6: Design of masonry structures

Eurocode 8: Design of structures for earthquake resistance

Règles de construction parasismiques des maisons individuelles CPMI-EC8 ZONE 5

✓ *Note: all dimensions are given by default. Designers can be exempted on the proviso that their calculations comply with DTU 20.1 and Eurocodes 6 and 8.*

Photos

CAUE [Conseil d'Architecture, d'Urbanisme et de l'Environnement – Council for Architecture, Town Planning and the Environment] Guadeloupe.

DEAL [Direction de l'Environnement, de l'Aménagement et du Logement – Environment, Planning and Housing Directorate] Martinique and Guadeloupe.

Délégation interministérielle pour la reconstruction des îles de Saint-Barthélemy et Saint-Martin [Interministerial delegation for the reconstruction of the islands of Saint Barthélemy and Saint Martin].

Diagrams

Laurent Stefano



PRACTICAL GUIDE ON POST-HURRICANE REPAIRS

WWW.SAINT-BARTH-SAINT-MARTIN.PREF.GOUV.FR – WWW.COM-SAINT-MARTIN.FR

PREFECTURE : 05 90 52 30 50 – COMMUNITY'S TOWN PLANNING DEPARTMENT : 05 90 52 27 30

