



---

# PRACTICAL GUIDE ON POST-HURRICANE REPAIRS

---

KEY POINTS TO IMPROVE SAFETY



Practical Information and Educational Sheet



## Introduction

By Julien Denormandie, Secretary of State for Territorial Cohesion

Hurricane Irma struck the West Indies with unprecedented force. Both in its effects and its impact on the population, Irma brought a wave of emotion and solidarity from French citizens around the world. Residents, elected representatives and departments acted quickly to address the issues of emergency housing, re-establishing the region's essential services and reconstruction.

Much has already been done. The protocol signed on 21 November 2017 between the French Government and the Collectivity of Saint-Martin set out areas of focus and measures to ensure that rebuilding is both exemplary and based on a spirit of solidarity. The risk prevention plan has been bolstered by taking flooding hazards near coasts into account. Certain rules regarding planning permissions have been relaxed and simplified while ensuring that risks remain properly taken into consideration.

The reconstruction work must take on board the lessons learned from the event and share the latest expertise in order to build on these lessons, prevent risks and ensure citizens' safety. This information sheet is the result of the simple belief that by working together to share best practices and provide information on risks and technical solutions, we can collectively move forwards and be better prepared for the future, learning from the past and from each other.

Properly assembled fastenings, appropriate equipment as well as design, installation and maintenance rules are not simply intended to provide comfort and ensure good-quality work. The aim is to properly build or re-build in the right place, while ensuring optimum risk management and mastering the techniques involved, with full knowledge of the risks and the appropriate solutions.

I would like to thank the contributors to this guide – engineers, architects, technicians, labourers and Government and Collectivity departments – without whose involvement progress would have been impossible.

There is still much to be done. We will never forget Irma, but St-Martin's recovery is bolstered by the determination of all stakeholders to rebuild this exceptional territory



Ladies and Gentlemen,

On September 6 of last year, a hurricane of unprecedented intensity devastated the island of St. Martin with wind gusts recorded at 400 kilometers per hour. In addition to the heavy human toll, hurricane Irma destroyed or damaged almost all of our infrastructure.

The Overseas Collectivité of Saint-Martin immediately realized that there would be a before and an after Irma. It needed to learn all the lessons from the passage of this hurricane to achieve the goal it set which is now the main thread of all its public policies: that of becoming a model of resilience and adaptation to climate change.

Today, that will is translated through the edition of a series of «Good Practices in Building and Housing Rehabilitation Guides» which result from a fruitful partnership between the French State and the Collectivité of Saint-Martin. Six different brochures which clearly detail step by step the choice of materials to use and the right actions to take to rebuild in accordance to the rules while keeping safety a priority.

"Safety is everyone's business", says the slogan: I strongly encourage all the professionals on the island as well as the entire population of Saint-Martin to make this valuable educational tool their own and to apply the useful advice that this Guide lists, so we can together reinforce the resistance of our housing and build a safer than ever Saint-Martin.

**Daniel GIBBES**  
President of the Overseas Collectivité of Saint-Martin





## Contents

1. Cross-disciplinary background information sheet .....	7
2. Risk information sheets .....	13
3. Practical information sheet .....	20
N° 1 Metal roofs	
N° 2 Timber frame	
N° 3 Windows and bay windows	
N° 4 Masonry	
N° 5 Timber structures	
N° 6 Awnings	
4. References.....	22



## 1. Cross-disciplinary background information sheet

This guide was produced following the most recent hurricane season, which was particularly intense and destructive for the French Antilles, especially the islands of Saint-Barthélemy and Saint-Martin. Both were significantly affected by Hurricane Irma on 6 September 2017.

This guide demonstrates the shared desire of the French Government and the Collectivity of Saint-Martin to capitalise on the lessons learned from this event, improving construction quality through an approach based on information and pragmatism. It is the result of a partnership-based collaborative effort between experts and professionals in the field and is designed to feed into construction practices across all overseas departments and territories that are faced with hurricane phenomena.

The hurricane caused considerable damage on both islands, particularly to their buildings. According to the CSTB's initial assessment of the building damage, which was carried out on 18 September 2017, the buildings affected by the hurricane primarily suffered damage because of:

- The lightweight nature of the structure itself, particularly in the case of makeshift housing.
- The connections between different components (attachment of roofs and canopies, attachment of railings, glass, etc.).
- The quality of the construction (excessive height with insufficient anchoring, lack of stiffeners in certain buildings, etc.).

In particular, it should be noted that concrete and masonry buildings were not structurally affected by the hurricane. In buildings of this type, the damage was generally limited to sheet-metal roofs, glass and railings. No structural damage to concrete and/or masonry buildings was recorded.



Figure 1: Damage to roofs



Figure 2: Damage to patio doors



Figure 3: Damage to lighter sections of masonry buildings



## 1.1 Purpose of this document

Hurricanes place significant loads on buildings. In addition to the direct effects of intense winds, hurricanes bring torrential rain and flooding. It has previously been noted that “a number of buildings in hurricane areas are too poorly designed, insufficiently sized or built with too little care to withstand such action”<sup>1</sup>.

To reduce the risks that hurricanes pose, stakeholders that work alongside architects, engineers and entrepreneurs have an important role to play and must also be made aware of hurricane-resistant construction. Location and design, sizing, implementation, maintenance and repair are all crucial steps in this process.

This guide is intended for construction professionals and non-professionals who perform repairs. It is intended both to be a reminder of the basic rules for making repairs and to make the reader aware of the need to maintain and check the building before each hurricane season.

However, the aim of this document is dependent on the reader’s experience:

- Professionals may use all information sheets as indications of what can be done quickly, reliably and without major design work. The references given at the end of the information sheets allow the recommendations to be adapted to fit the situations professionals may encounter;
- It is recommended that non-professionals use only the information sheets related to the building envelope, with no impact on the building structure (“Public information sheet” on the cover leaf). The rules stated must be followed as closely as possible.

## 1.2 Importance of building location and compliance with current planning and building regulations (photos and explanatory diagrams)

This guide does not cover building from scratch, nor does it cover major reconstruction work. In these cases, in-depth reflection on the building’s location and on its design is highly recommended in order to reduce the risks.

Being aware of the importance of the location of the building and the quality of the design and its implementation is essential. The new hazard map, presented to the Collectivity on 17 January 2018, highlights areas at significant hurricane risk, supplementing the natural risk prevention plan of 2011, which is still in force. Repairs made in accordance with this guide do not guarantee the building will withstand a hurricane season, particularly in the case of buildings that have previously been weakened. In addition, following the instructions in this guide does not constitute permission to construct or rebuild a building.

### ATTENTION

Repairs made in accordance with this guide do not guarantee the building will withstand a hurricane season, particularly in the case of buildings that have previously been weakened. In addition, following the instructions in this guide does not constitute permission to construct or rebuild a building.

1. Les Grands Ateliers de L’Isle-d’Abeau, Conception paracyclonique à l’usage des architectes et ingénieurs, 2011



### 1.3 Importance of proper building design

The architectural design of structures plays an essential role in their ability to resist extreme winds and earthquakes. The task must be left to the greatest extent possible to professionals: architects and design consultants.

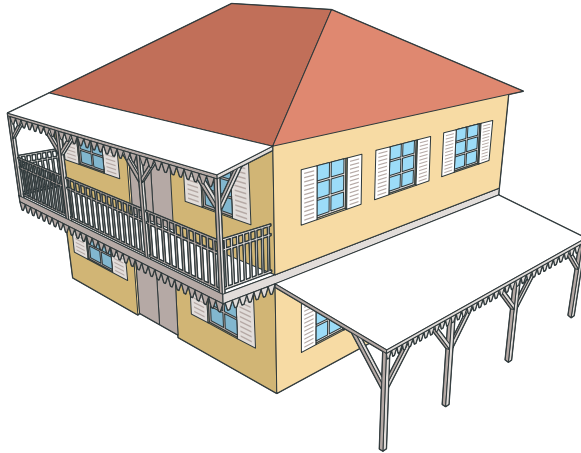

Figure 4: Example of a house with a simple design

A building will have a greater chance of withstanding violent events if it follows a number of basic rules:

- It should have a simple shape that is as square or rectangular as possible.
- Projecting components such as canopies and sunshades must be as compact as possible.
- The roof must also be simple in shape with few openings.
- Earthquake- and hurricane-resistant structural components must be used wherever possible, whether vertically or horizontally: all outside walls and floors must be earthquake- and hurricane-resistant.
- All components must be properly linked together.

## 1.4 Importance of quality construction materials and their proper implementation

The most common building construction method is for heavy structures (concrete or masonry). Around 20% are low-built, ground-floor buildings made of wood or with a metal framework. The widespread use of steel or aluminium sheets for roofs, which are generally double-pitched, should be noted.

Wherever possible, contracting qualified construction professionals and using high-quality materials that meet European earthquake and hurricane standards is strongly recommended. In addition, regular maintenance of the building and all of its components is essential. Details of this maintenance are given in the information sheets below.

These information sheets are broken down by the main trades involved. However, the attention of all those involved should be drawn to the importance of the connection between the different components of the building, particularly when different materials are being used.

## 1.5 Choice of materials

Choosing the right building materials and products is of prime importance to the safety and durability of the buildings. The information sheets included in this document each give selection criteria that will be useful when choosing products. The performance levels meeting the criteria must be specified by the manufacturer and marked directly on the product or the accompanying label. For this information to be usable, it must be specified in a precise format, namely the format associated with the CE mark.

### ■ CE marking

Regulatory CE marking is generally mandatory when placing a product on the market. Its aim is to facilitate the free movement of products within the European Economic Area, as it demonstrates the product's compliance with the fundamental requirements of European regulations and directives, including the Construction Products Regulation (CPR).

The Construction Products Regulation (EU Regulation no. 305/2011) entered into force on 1 July 2013 and requires all construction products that are compliant with a harmonised standard or a European Technical Assessment to have a Declaration of Performance and to bear the CE mark in order to be placed on the market.

For construction products, the CE mark indicates that the manufacturer takes responsibility for the product's compliance with the performance levels stated in the Declaration of Performance when placing the said construction product on the market.

To affix the CE mark onto its product, the manufacturer must, at various stages, perform initial technical assessment testing and factory production controls.

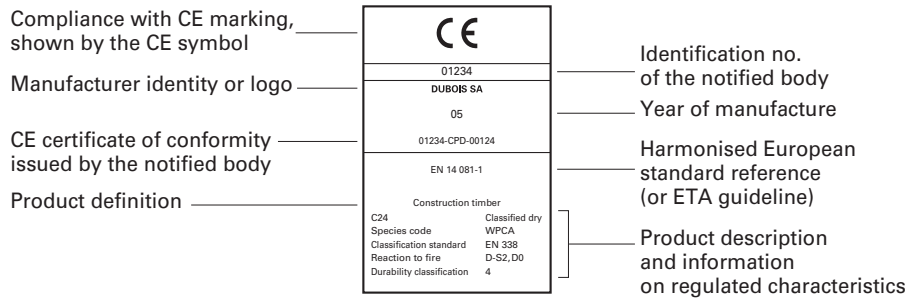

Figure 5: Example of a CE marking label

### ■ How to recognise a CE product

The first way of recognising a CE product is the logo shown below. This logo is mandatory if the product is covered by CE marking. It must be clearly displayed on the product or on the accompanying label.



Figure 6: Logo identifying a CE-marked product

This marking is generally accompanied by a label on which a range of relevant performance data about the product is given (Figure 2). The manufacturer is also required to make available a “Declaration of Performance” in which all required information is given. Consulting this declaration before using a given product is advised.



## 2. Risk information sheet

### 2.1 Earthquakes

The risk of earthquakes is a well-known, major risk in the West Indies. Several recent earthquakes have acted as a reminder of this and recent disasters remain ingrained in people's memories. In terms of buildings, earthquakes involve a movement of the ground in all three directions. This movement depends on a number of factors:

- The characteristics of the earthquake, particularly its depth and strength.
- The type of earth through which the force of the earthquake moves to the building.
- The building's direct environment, such as the relief or whether large buildings are in the immediate area.

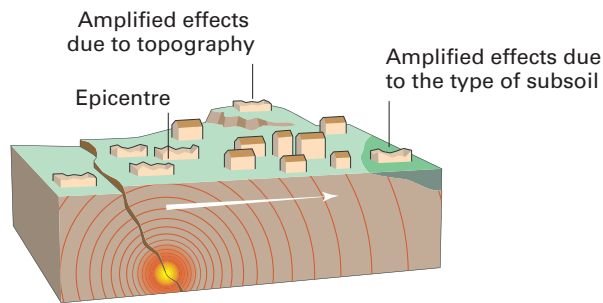

Figure 7: The effects of earthquakes

During earthquakes, buildings move with the ground. The inertia resulting from their mass puts strain on the structure, which then becomes distorted as a result. As the building's mass is located at its floors, the force must be transferred to the walls, then to the foundations. To ensure this transfer can take place, the buildings' structure must meet a number of criteria:

- On all storeys, have floors that are sufficiently rigid to prevent deformation, thus involving all walls in the absorption of the force (diaphragm effect). This rule also applies to the top of the last level, located directly underneath the roof framing.
- Add bracing walls (which absorb force) at regular intervals and, above all, symmetrically to the building plan.
- Use the most compact ground plan possible.
- Use a similar floor plan on each floor of multi-storey buildings. Floor surfaces must not vary by more than 20%. All secondary components must be properly attached to the structure.

## 2.2 Hurricanes

Hurricane Irma was a reminder of just how violent such storms can be. Hurricanes develop over the ocean when the surface water temperature is above 26° and at locations sufficiently far from the equator for Coriolis forces to reach the level required for spin.

This means that, aside from equatorial regions with a latitude of around 7° or less, hurricanes affect all coastal and island areas of marine zones between the tropics.

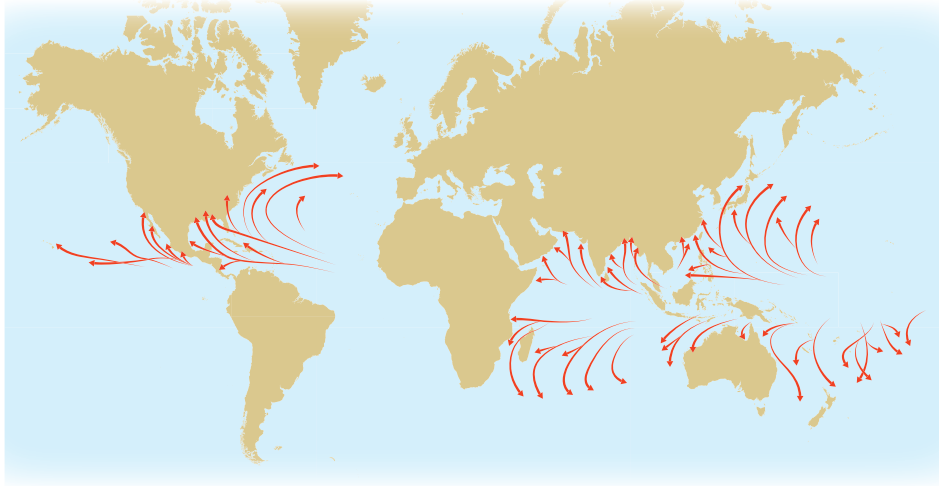

Figure 8: Hurricane areas

While hurricanes have a major and immediate impact on the safety of people and property, the everyday climate is characterised by conditions that affect residents' comfort. It generally features consistent winds (in both direction and strength), high temperatures and high humidity levels, long periods of sunshine and significant rainfall. Construction requirements in these climates are often linked to these more everyday requirements. The search for comfort – except where it involves using artificial climate control techniques that make buildings entirely airtight, which should not be encouraged as part of a sustainable development approach – therefore leads to a highly permeable architecture that promotes natural ventilation and to multiple extensions. Conservatories, canopies and other light components are clearly particularly vulnerable to wind action. As such, designing a home that is perfectly suited to the humid tropical climate necessarily means simultaneously taking into account the issues of safety and of comfort. This twin-pronged approach requires proper implementation of construction practices and knowledge of the aerodynamic mechanisms in play.

In addition, economic constraints lead a significant proportion of the population to prefer light – and frequently self-built – constructions, which are more fragile than masonry-built constructions.

In addition to correctly calculating the building size in accordance with proper construction practices, hurricane-resistant design alters the aerodynamic field around the building to change how pressure is distributed, thus minimising the action of the wind. The building structure and envelope is then subject to lower loads and their sizing can be reduced.

■ **Site impact:** depending on the site, exposure to hurricane winds varies: for a given hurricane event, the geographical location, topography and the nature of the environment reduce or increase the local wind speed. As a result, the aerodynamic load on a building is dependent upon its location. This impact can be mapped using topographic surveys of the area in question.

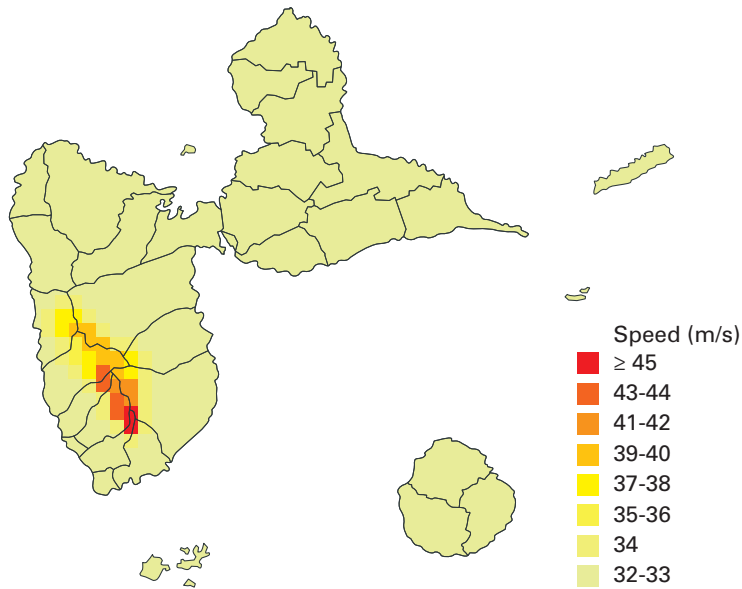

Figure 9: Map of hurricane winds in Guadeloupe. Wind speed taking account of local relief.

■ **Impact of the immediate environment:** the immediate environment directly affects the aerodynamic phenomena to which the building is subject. Observation of the existing building within the immediate scope of the project (radius  $\geq 100$  to 150 m) is needed to judge the increase in risk or, on the other hand, to assess the protection that is provided (masking effect).

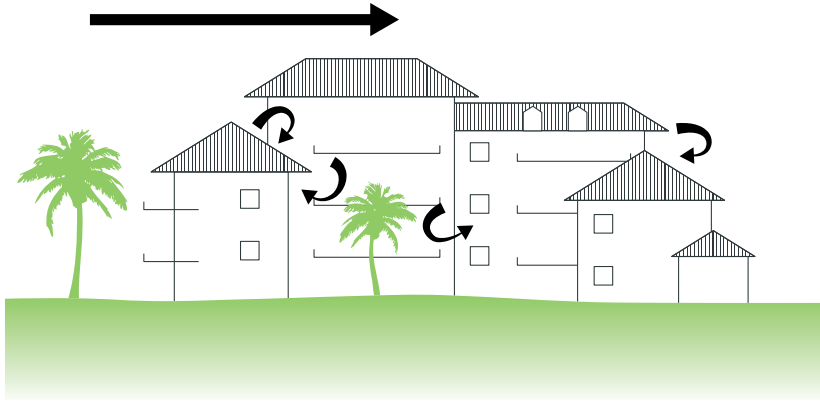
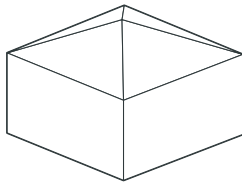
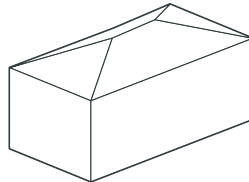

Figure 10: Sheltered area

■ **Impact of shape:** The overall geometry of the building affects how it responds to wind. A significant reduction (by a factor of 1.5) in the resulting forces (limiting loads) can be obtained by using compact geometric shapes (such as an octagonal floor plan). More compact forms can also be used, which act in three dimensions in response to wind. Four-sided, hexagonal and octagonal shapes with approximately equivalent footprints covered with a pitched roof with multiple faces (at least four) thus help to significantly reduce the impact of the wind.



1 - Square design



2 - Rectangular design

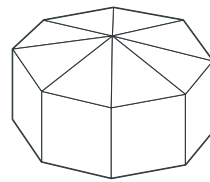

3 - Octagonal design

Figure 11: Géométrie globale de l'ouvrage

■ **Impact of the roof, slope and number of pitched roof faces :** The roof slope is a factor that is very sensitive to the loads exerted by the wind. For double-pitched roofs with a slope of less than  $20^\circ$ , when subject to wind, the roof space experiences significant low pressure and there is a high risk of roof blow-off. On the other hand, increasing the slope means a reduction in this extreme low pressure, lowering the risk of roof blow-off. Furthermore, regardless of the slope, the roof edges still remain highly exposed areas. For this reason, choosing a roof with four sloped faces gives a significant reduction in the blow-off forces experienced compared to a double-pitched roof. In the case of side winds, the load acting on the roof is reduced by around 50%. This reduction occurs predominantly at the roof edges, an area subject to particularly heavy load, and, generally, the forces are better distributed across the entire load-bearing structure.

In summary, a building that is optimised both for general wind action across the roof and for local action at the overhangs and edges, should feature:

- a more compact volume that is cube-like in shape;
- a roof with four sloped faces (as a minimum);
- a slope of around  $30^\circ$  with small overhangs.

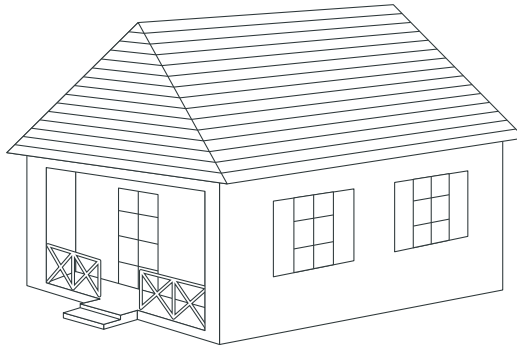

Figure 12: Optimum construction

■ **Uncoupling of trigger points from the structure:** Uncoupling the main roof from secondary components, such as conservatories and canopies, is advised. It is also possible to remove any roofing components from the main covering that could be torn off by the wind. This principle of safeguarding the key components of the walls and roof can be adapted to suit both existing buildings and new properties.

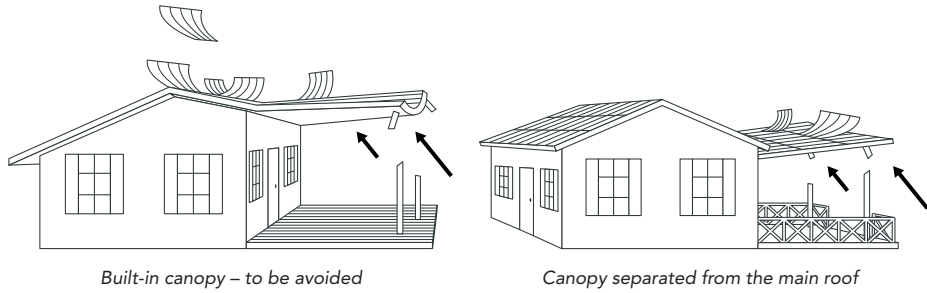

Figure 13: Separation of the main roof and canopy – trigger points

## 2.3 Conclusion

Both earthquakes and hurricanes have a range of impacts on buildings. In some cases, the solutions are similar, while in others, they can be contradictory. The rules set out in the two previous paragraphs are, however, compatible. Important factors in both cases are:

- The compact nature of the building;
- Proper connections between all components, including non-structural components.

As a result, proper design with respect to resistance to one of the phenomena will have a positive effect on resistance to the other.

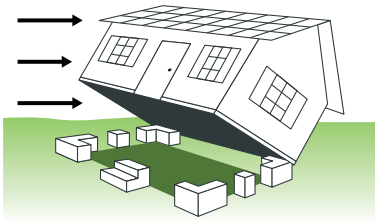

Figure 14: House lifted up (wind and earthquake)

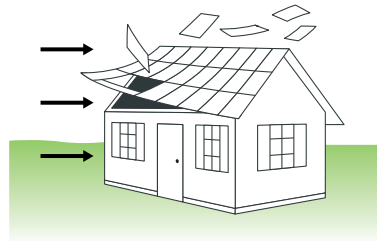

Figure 15: Roof frame torn off (wind)

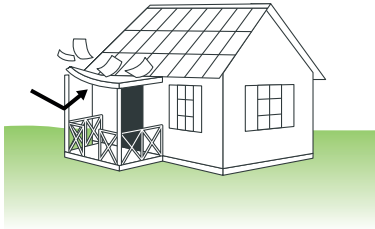

Figure 16: Canopy torn off (wind)



Figure 17: Cracks in solid walls (earthquake)

### 3. Practical information sheets

These practical information sheets have been created in order to indicate which measures should be taken to ultimately achieve a good level of safety. In each case, the aim is to state:

- The damage observed following Hurricane Irma;
- The materials required for repairs;
- How to proceed with the repairs;
- The maintenance that will be required.

For repairs, only part of the building must be affected. It is recommended that an inspection of the unaffected part of the building be carried out to ensure that it meets the criteria given in the information sheets. If this is not the case, it is best to strengthen this part of the structure as well.

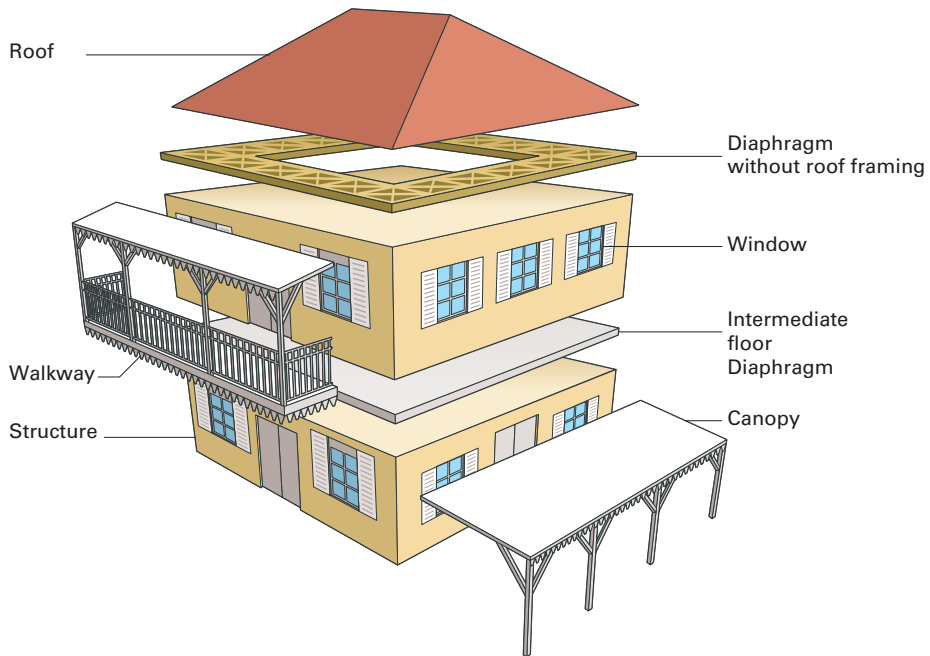
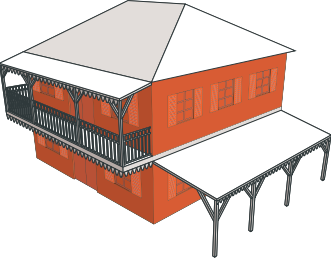
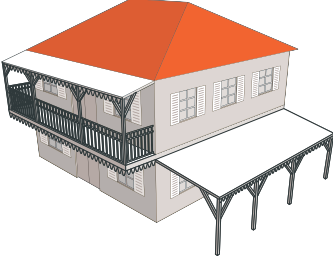
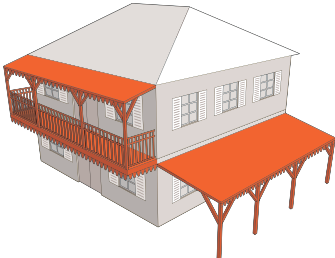
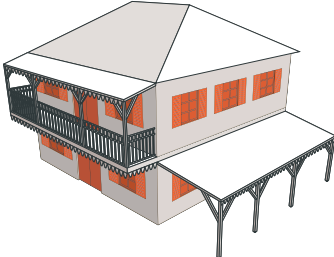

Figure 18: Details of components covered in the information sheets



Category	Information sheets	Illustration
Structure	Masonry: Practical Sheet N°4 Timber structures: Practical Sheet N°5	
Roof	Timber frame: Practical Sheet N°2 Metal roofs: Practical Sheet N°1	
Projecting components	Awnings: Practical Sheet N°6	
Woodwork	Windows and bay windows: Practical Sheet N°3	

## 4. References

### Bibliography

CSTB, *Habitat cyclonique: concept adapté à l'auto-construction*, 1998

Les Grands Ateliers de L'Isle-d'Abeau, *Conception paracyclonique à l'usage des architectes et ingénieurs*, 2011

*Conception cyclonique*, Concepts aérodynamiques et conseils pratiques – cahier du CSTB 3311 – Sophie Moreau, Jacques Gandemer and Guy Barnaud

*Règles de construction parasismiques des maisons individuelles CPMI-EC8 ZONE 5*

*Guide to Dominica's housing standards*, Dominica Ministry of Planning, 2018

### Photos

The photos included in the information sheets were provided by:

CAUE [Conseil d'Architecture, d'Urbanisme et de l'Environnement – Council for Architecture, Town Planning and the Environment] Guadeloupe.

DEAL [Direction de l'Environnement, de l'Aménagement et du Logement – Environment, Planning and Housing Directorate] Martinique and Guadeloupe.

*Délégation interministérielle pour la reconstruction des îles de Saint-Barthélemy et Saint-Martin* [Interministerial delegation for the reconstruction of the islands of Saint Barthélemy and Saint Martin].

### Diagrams

Laurent Stefano

### *Acknowledgements*

For the combined generosity of their contributions, the Interministerial Delegation for the Reconstruction of Saint-Barthélemy and Saint-Martin would like to thank:

The Centre Scientifique et Technique du Bâtiment; the Direction de l'Habitat, de l'Urbanisme et des Paysages [the French Housing, Town Planning and Landscape Department]; the Cabinet of Mr Julien Denormandie, Secretary of State to the Minister for Territories' Cohesion; the Cabinet of Mr Daniel Gibbes, President of the Overseas Collectivité of Saint-Martin.

Romain Kereneur and Maureen Maquin for the DHUP, Philippe Leblond and the project team for the CSTB, Noëlie Carretero for Cerema ; M. Gauthier Grienche, M. Lébert Mimifir et Mme Françoise Varin pour la DEAL de la Guadeloupe ; M. Frédéric Vaudelin pour la DEAL de la Martinique ; M. Axel Grava, M. Jean-Bernard Lamasse, M. Jack Sainsily et Mme Françoise Troplent pour le CAUE de la Guadeloupe, Mme Aline Hannouz et M. Lionel Orsi, Architectes Conseil de l'État ; Mme Karine Meaux pour la Fondation de France.

M. Sédar Cadrot pour Alcor Consulting ; M. Christian Chams pour CH2 Techni Control ; M. René Coconnier pour Groupe SMA ; M. Gilles Courteboeuf pour Socotec ; Mme Yseult Dubernet pour Y Agency ; M. Lionel Firmin pour Eco Conception Antilles ; M. Raphaël Firmin pour ECP Brouks ; M. Jean-Paul Gouget ; M. Yves-Marie Jhigai pour JYM Studio ; M. Thierry Maggi et M. Pascal Marigo pour GLM Service ; M. Philippe Michaux ingénieur pour FRBTPS, M. François Montezume pour LCPLP ; Mme Christine Pouzet ; M. Didier Rouault Président de l'association des architectes de Saint-Martin ; Mme Jeanne Salomé pour A2 Studio ; M. Olivier Scherrer pour les Compagnons bâtisseurs ; M. Laurent Sochet pour Guez Caraïbes ; M. Paul Turbet Delof pour Elis ; M. Joris Vanden Eyde pour ICE Sint Maarten.



**PRACTICAL GUIDE ON POST-HURRICANE REPAIRS**

**[WWW.SAINT-BARTH-SAINT-MARTIN.PREF.GOUV.FR](http://WWW.SAINT-BARTH-SAINT-MARTIN.PREF.GOUV.FR) – [WWW.COM-SAINT-MARTIN.FR](http://WWW.COM-SAINT-MARTIN.FR)**

**PREFECTURE : 05 90 52 30 50 – COMMUNITY'S TOWN PLANNING DEPARTMENT : 05 90 52 27 30**

